

Article number: 208050211

Description: E+G Sphericalwasher male DIN 6319-21-C-NI
Stainless Steel 1.4305

Measures

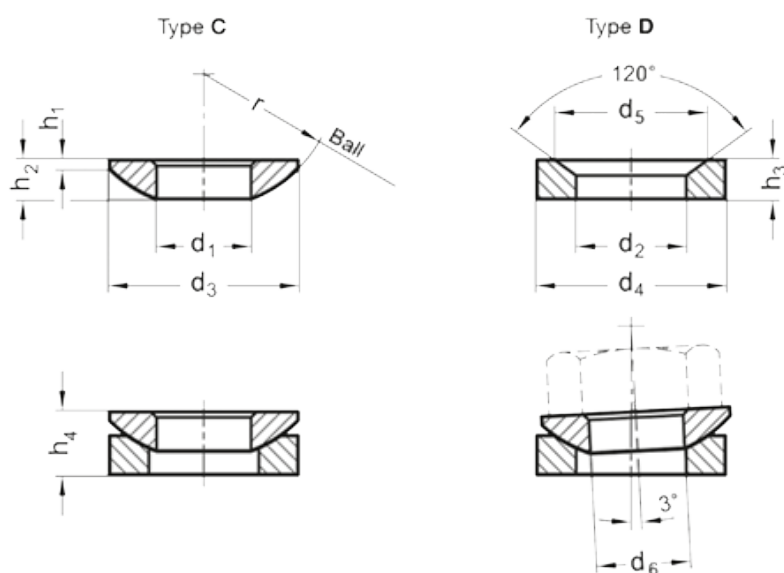

$d_1 = 21.0$

$d_3 = 36$

$d_6 = M20$

$H_1 = 2.0$

$H_2 = 6.3$

$H_4 = 11.7$

$r = 27$